

Article number: 2031100M16125B3VK

Description: E+G levelling foot
GN 31-100-M16-125-B3-VK

Note: VK With nut, External hexagon at the top, Wrench flat at the bottom

Measures

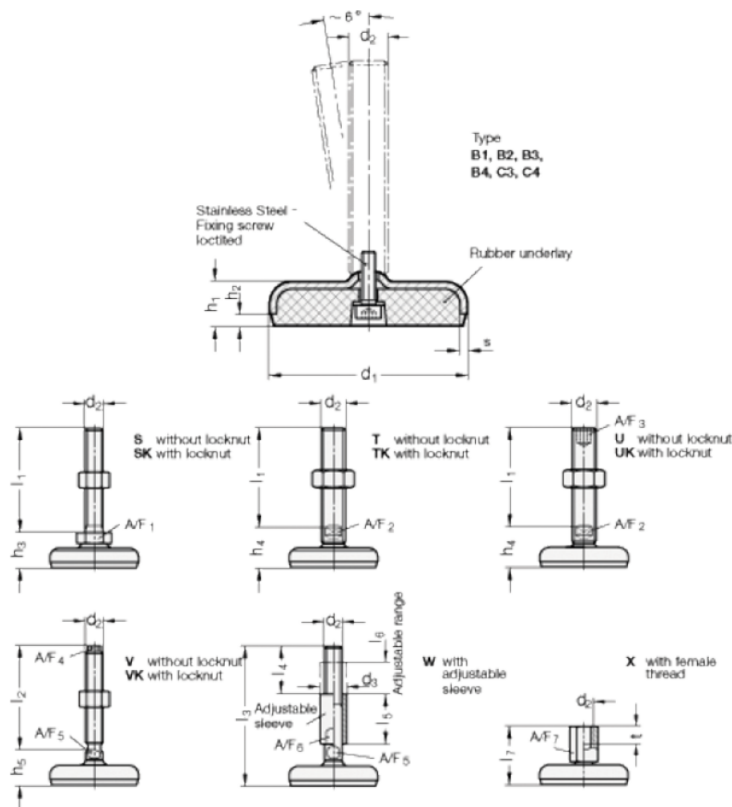

A/F4	= 10	s = 3
A/F5	= 12	
d1	= 100	
d2	= 16	
h1	= 20	
h2	= 6	
h5 +4.0/0	= 31	
l2	= 125	